

Atria 6 - Standard



- 6-inch aperture high lumen cylinder with lumen output 3470 – 9250lm.
- Outdoor/Natatorium Rating
(Please refer to Outdoor/Natatorium Version spec sheet)
- Tunable White
(Please refer to Tunable White Version spec sheet)
- Warm Dim
(Please refer to Warm Dim Version spec sheet)
- W+RGB
(Please refer to W+RGB Version spec sheet)

Quantity		Type	
Project		Note	

Electrical System

- 3895lm (40W)
- 6180lm (60W)
- 7845lm (80W)
- 9250lm (100W)
- Power Input: Universal (120-277V)
- Operating Temperature: -13°F~112°F
- Surge Protection: 4KV
- Remote Emergency Pack: Bodine BSL20LV
- Power factor greater than 0.9

LED Technology

- 2700K, 3000K, 3500K, 4000K
- 85 CRI, 93 CRI
- Beam Angle: 40°, 60°, WD
- Glowing Ring Option
- Rated Life > 60,000 hours (L70)

Advanced Dimming

- (Proprietary VX Driver is incorporated to all dimming options for video flicker-free lighting)
- Standard 0-10V: dims to 10%
 - Superior 0-10V: dim to 1 %
 - DMX: high resolution dims to 0.1% (Supports ANSI E1.20 RDM protocol)
 - LTE: Hi-Lume 1% 2-Wire LED Driver (120V forward phase only)
 - LDE1: Hi-Lume 1% EcoSystem LED Driver with Soft-on, Fade-to-Black (UNV only)
 - DALI: dims to 10%

Housing

- Diameter: 6.4" (164mm)
- Height: 15" (381mm)
- Material: Aluminum
- Weight: 19.8 lbs

Mounting

- Surface Mount
- Stem 2ft or 4ft; 45° Swivel Canopy Included
- Adjustable Aircraft Cable 10ft
- Yoke Mount (AC/Dimming cable length: Standard / 6ft)
- Wall Mount

Warranty

- 5 years limited warranty.

Listing

- ETL Damp Location Listed
- FCC
- CE



Atria 6 - Standard





How To Specify:

Ordering Example:AS6-100-408-UNV-DMX-40-STD-BLK-SUM

4-5 weeks lead time on over 75% of specifications.

Model	Wattage	CCT / CRI	Voltage	Dimming
AS6			UNV	
AS6	40 40W	278 2700K / CRI85	UNV 120-277V	STV Standard 0-10V dims to 10%
Atria 6	60 60W	308 3000K / CRI85		SPV Superior 0-10V dims to dark
	80 80W	358 3500K / CRI85		DMX¹ DMX dims to 0.1% (XLR Sockets)
	100 100W	408 4000K / CRI85		DMX(RJ45) DMX dims to 0.1% (RJ45 Sockets)
		279 2700K / CRI93		LTE Hi-Lume 1% 2-Wire LED Driver (120V forward phase only)
		309 3000K / CRI93		LDE1 Hi-Lume 1% EcoSystem LED Driver with Soft-on,Fade-to-Black (UNV only)
		359 3500K / CRI93		DALI¹ DALI dims to 10%
				¹ Wall Mount DMX does not include XLR / RJ45 sockets

Beam Angle	Finish	Rim Finish	Mounting	Accessories	
40 40°	BLK Black	 STD Without Ring	SUM Surface Mount	SPD¹ Surge Protector	
60 60°	WHT White		 GLR Glowing Ring	ST2 Stem 2ft	EMP Remote Emergency Pack
WD* WIDE				ST4 Stem 4ft	DF² Diffuser
			AD10 Adjustable Cable 10ft		
			WLM* Wall Mount		
			YKM Yoke Mount		
Please factor in change in lumen output with diffuser(-20% with WD; -12% with other degrees).			*Wall Mount DMX wiring is through 2 DMX Positive / Negative wires ¹ Surge protector for up to 10KV. Applicable for unstable mains or facilities using high power machineries. ² Please factor in change in lumen output with diffuser (-20% with WD; -12% with other degrees).		

Atria 6 - Standard



Delivered Lumens*

Wattage \ CCT	40W	60W	80W	100W
Beam Angle: 40°				
4000K	3895 lm	6180 lm	7845 lm	9250 lm
3500K	3710 lm	5890 lm	7620 lm	9130 lm
3000K	3640 lm	5780 lm	7195 lm	8900 lm
2700K	3470 lm	5500 lm	6725 lm	8210 lm

*Tolerance±8%

Current Consumption

Wattage \ Volt	120V	277V
40W	0.37A	0.16A
60W	0.55A	0.24A
80W	0.73A	0.32A
100W	0.92A	0.40A

Dimensions

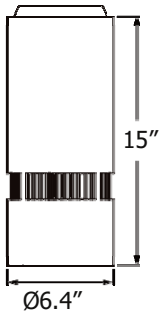

Appearance

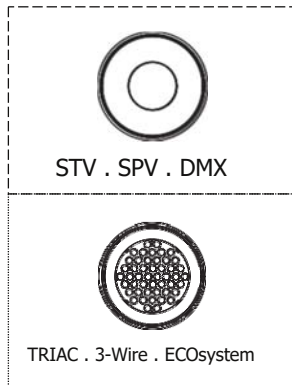

Mounting Options

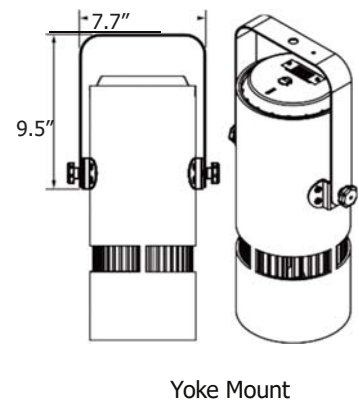
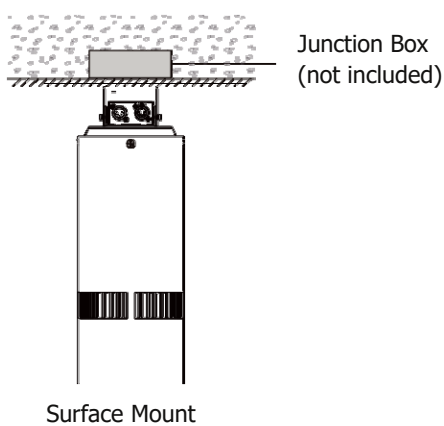
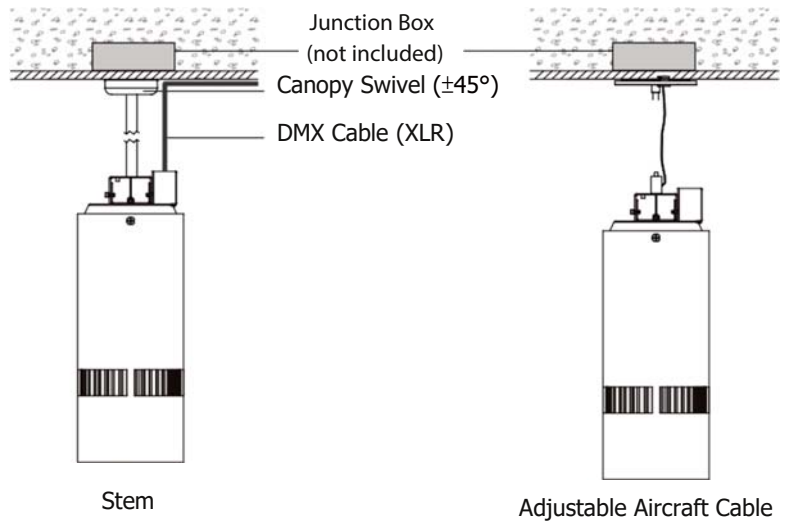

Atria 6 - Standard



DMX Requirements

The AS6 LED fixture with DMX is a ONE CHANNEL DMX unit.

When placing order, please indicate DMX address. (The DMX address will be listed on the back of the fixture.)

The LED fixture provide RJ45 Socket or XLR socket to connect. (DMX cable NOT included.)

The final fixture should be terminated by the use of DMX Terminator (by others).

RJ45 Sockets

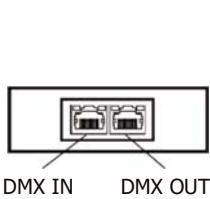

XLR Sockets

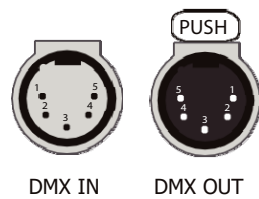

CONNECTION	RJ45 (CAT5e)	5-PIN XLR
Common	WHITE/BROWN(PIN7) & BROWN(PIN 8)	PIN 1
Signal -	ORANGE(PIN 2)	PIN 2
Signal +	WHITE/ORANGE(PIN 1)	PIN 3
Spare	-	PIN 4
Spare	-	PIN 5

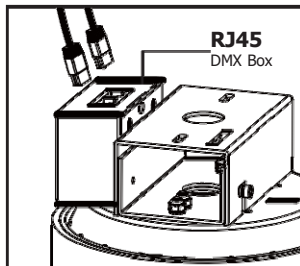

Connect DMX by using a standard shielded CAT5/6 cable.

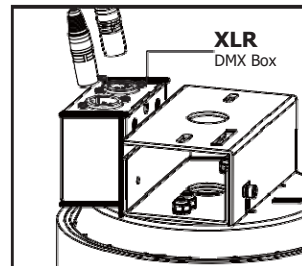

Connect DMX by using a standard DMX512 XLR cable with 5 pin in/out connector (by others).

DMX Wall Mount Wiring Diagram

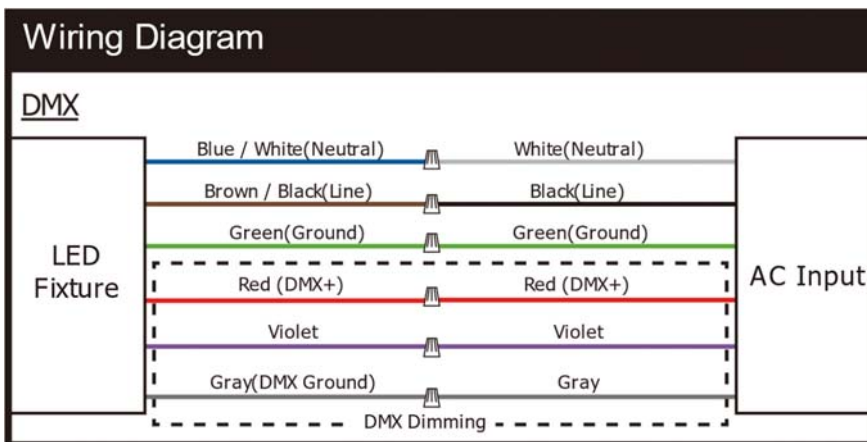

- When placing order, please indicate DMX address. (The DMX address will be listed on the back of the fixture.)
- The LED fixture will have 2 DMX positive / Negative wires for connection.
- The final fixture should be terminated by the use of DMX Terminator (by others).

Compatible TRIAC Dimmer List

LUTRON PART NO

RRD-6NA-	RRT-G5NEW-	RRT-GH	HQRD-10ND-	HQRT-GH	HQRD-HN	PD-10NXD-
RRD-6ND	RRT-G25LW-	HQRD-6NA-	MRF2-6ND-120-	HQRT-G25LW-	GT-250M-	PD-5NE-
RRD-10ND-	RRD-HN	HQRD-6ND-	MRF2S-6ND-120-	HQRT-G5NEW-	GTJ-250M-	

Emergency Pack Lumen Output Table

CCT	2700K	3000K	4000K	5000K
Lumen	1640 lm	1760 lm	1890 lm	1950 lm

Remote Emergency Pack

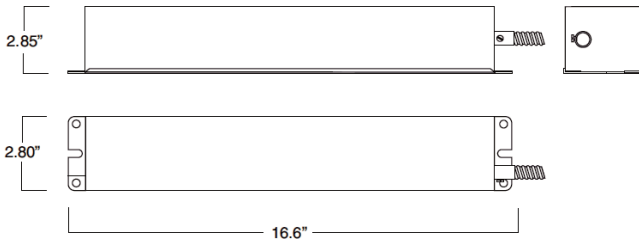

Mounting with standard ceiling recessed Junction BOX

